



# LED POWER SUPPLY DATASHEET

**SNP15-24VF-1**

**DESCRIPTION**

High Cost Performance, SELV, Open circuit, short circuit, overload and over temperature protection. Compliance to ERP directive, lifetime 30,000hrs.



**Input**

Items	Conditions	Request	Note
Input voltage	Ta	200-240V	--
Input frequency		50/60Hz	--
Input current	25°C, rated input voltage, output with max. rated power	< 0.23A	--
Input power		< 20W	--
Efficiency		≥ 84%	--
Standby		25°C, rated input voltage, output without load	< 0.5W
Inrush current	25°C, rated input voltage,	< 70A	Peak
PF	25°C, rated input voltage, output with max. rated power	≥ 0.5	--

**Output**

Items	Conditions	Request	Note
Startup time	25°C, rated input voltage, output with max. rated power	< 0.5S	--
Rated output voltage and precision	Ta, rated input voltage, output with rated power	24V±5%	--
Output current range	Ta, rated input voltage	0-0.625A	
Output voltage wave	25°C, rated input voltage, output with max. rated power	< 500mV	Vp-p
Output overload	25°C, rated input voltage, output with 2 times LED load	--	--
Output current and precision	Ta, rated input voltage, output with rated power	--	--
Rated output voltage range	Ta, rated input voltage,	--	--
Output current wave	25°C, rated input voltage, output with max. rated power	--	Ip-p
Dimming mode	--	--	--
Dimming range	--	--	--

**Temperature and others**

Items	Conditions	Request	Note
Operation temperature	--	-20-45°C	--
Relative humidity	--	45%-85%	--
Max. case temp.	--	80°C	--
Lifetime	Max. Ta, rated input voltage, output with max. rated power	30,000hr	--
Working noise	25°C, rated input voltage, output with rated power, mute box background noise < 35dB, pickup 10cm distance from products	yes	--

**Mechanical, mounting and wiring mode**

Items	Conditions
Case material and size	Plastic 103x35.5x16mm
Mounting ways	Independent
Insulation type	Class II
IP grade	IP20
Input cables dimension	H03VVH2-F 2X0.75mm <sup>2</sup>
Output cables dimension	H03VVH2-F 2X0.75mm <sup>2</sup>
Output cables length	Max. 2 meters

**Protection**

Items	Conditions	Request	Note
Open circuit	Ta, rated input voltage, no load	--	--
Over load	Ta, 0.94-1.06 times of input voltage, 1.5 times of output rated power	Yes	--
Short circuit	Ta, 0.94-1.06 times of input voltage,	Yes	--
Over temperature	Ta, 0.94-1.06 times of input voltage, temperature detected points more than 115 degree	--	--
Output over voltage	Ta, 0.94-1.06 times of input voltage, output voltage is 1.3 times of rated one	--	--
Auto recovery	Overload, Short circuit, over heat revocation	Yes	--
Latch off	Over temperature, over voltage re-start after cut off	--	--

**Standard**

Items	Conditions
Safety	IEC61347-1, IEC61347-2-13
Harmonic	EN61000-3-2 Class C
EMI	EN55015
EMS	EN61547

Dimensions(mm)

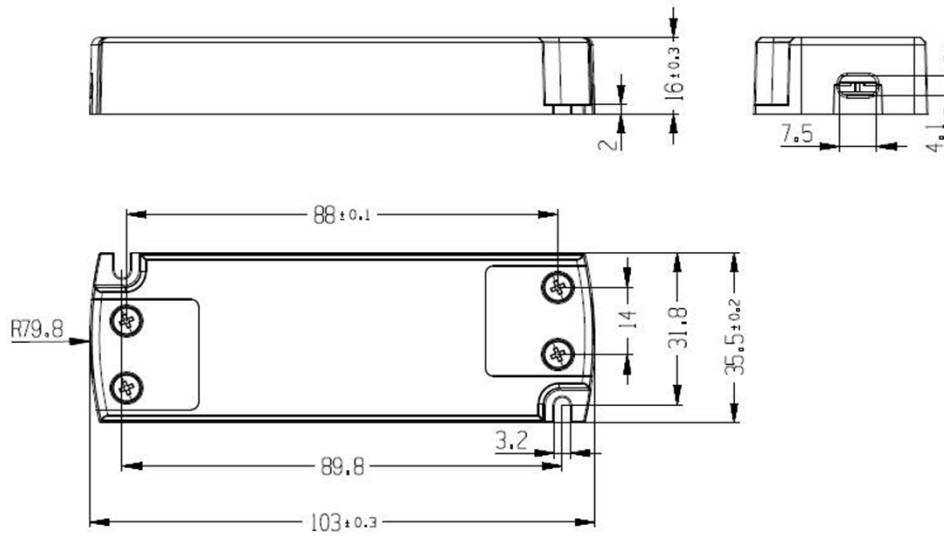

Wiring Diagram

